

N86164 Component list

P/N	Part description	Q'TY	Unit	Remarks
T-01	The base	1	Pc	
T-02	Screws M5	2	Pcs	
T-03	Pole	1	Pc	
T-04	Frame	1	Pc	
T-05	Nut M8	4	Pcs	
T-06	Ring M8	4	Pcs	
T-07	Hook	4	Pcs	
T-08	Peg	1	Pc	

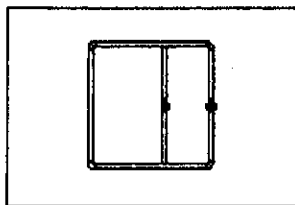

1Pc

T-01

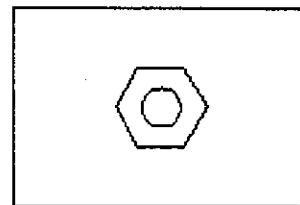

4Pcs

T-05

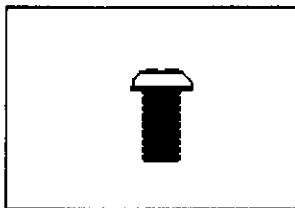

2Pcs

T-02

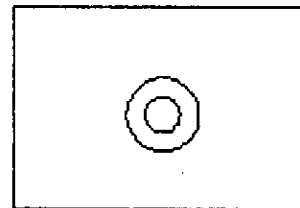

4Pcs

T-06

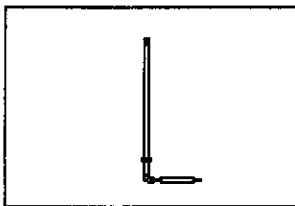

1Pc

T-03

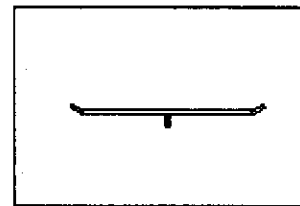

4Pcs

T-07

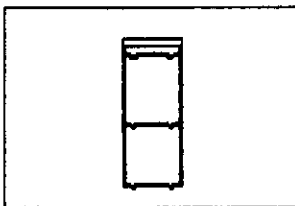

1Pc

T-04

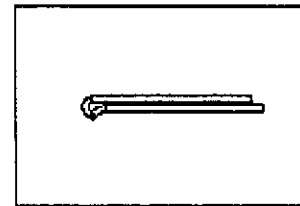

1Pc

T-08

INSTRUCTIONS

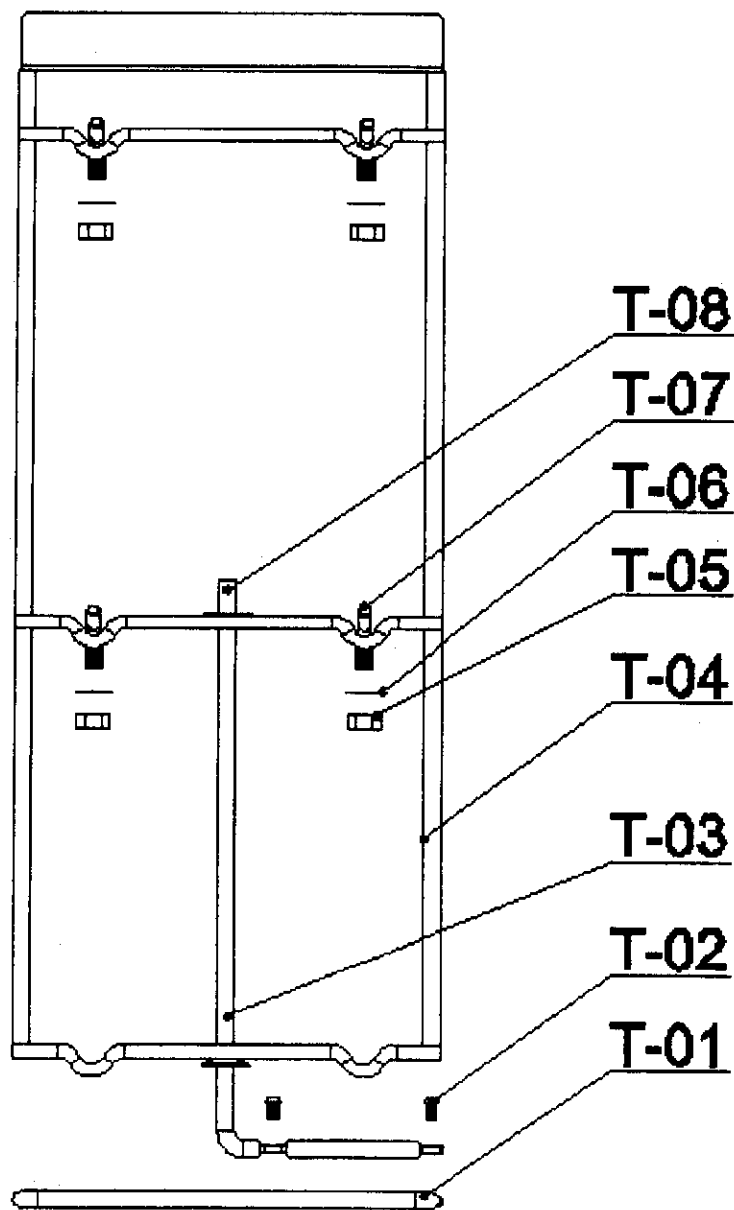

N86164