

# INSTRUCTIONS

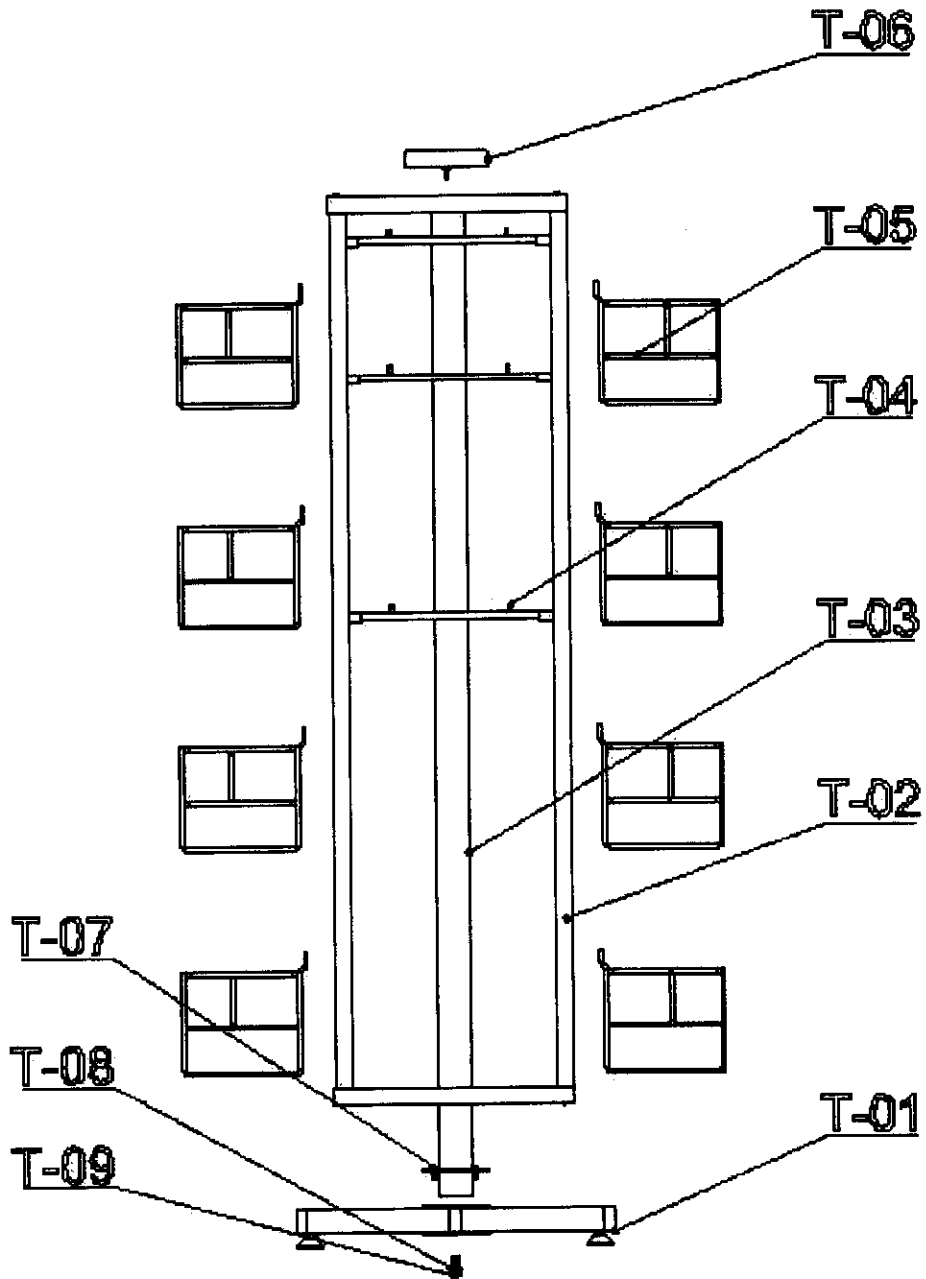

50998

### 50988 Component list

P/N	Part description	Q' TY	Unit	Remarks
T-01	The base	1	Pc	Fbr 4 adjust screws
T-02	rack body	1	Pc	
T-03	Pole	1	Pc	
T-04	Hooks	6	Pcs	
T-05	Wire basket	8	Pcs	
T-06	Name-plate	1	Pc	
T-07	Screws M6	4	Pcs	
T-08	Ring M10	1	pc	
T-09	Screw M10	1	pc	

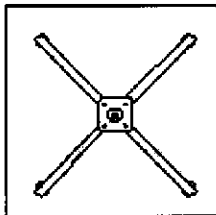

1Pc

T-01

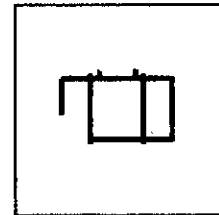

8Pcs

T-05

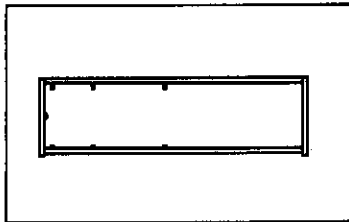

1Pc

T-02

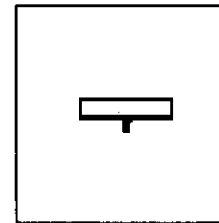

1Pc

T-06

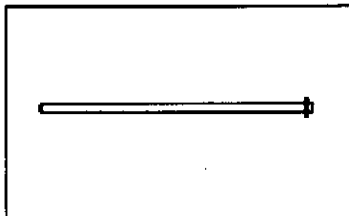

1Pc

T-03

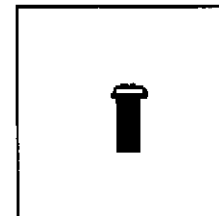

4Pcs

T-07

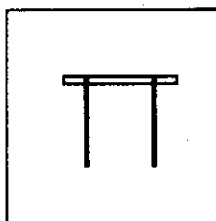

6Pcs

T-04

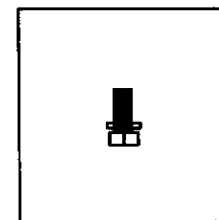

1 set

T-08 T-09