

17997 Component list

P/N	Part description	Q' TY	Unit	Remarks
T-01	The base	1	Pc	To be fixed adjust screws
T-02	The pole	1	Pc	
T-03	Down frame group	1	Pc	
T-04	Basket- A	3	Pcs	
T-05	Basket- B	10	Pcs	
T-06	Basket- C	10	Pcs	
T-07	Up frame	2	Pcs	
T-08	Short tube	1	Pc	
T-09	Name-plate	1	Pc	
T-10	Screws M6*30	7	Pcs	
T-11	Ring M10	1	Pc	
T-12	Screw M10	1	Pc	

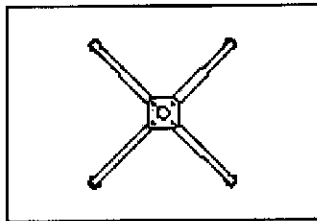

1Pc

T-01

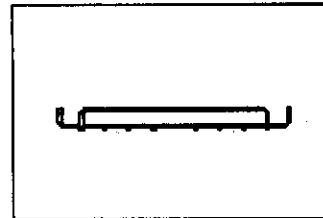

3Pcs

T-04

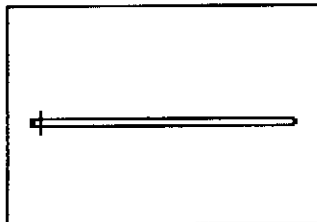

1Pc

T-02

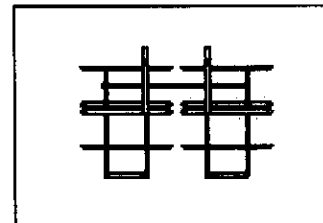

10Pcs

T-05

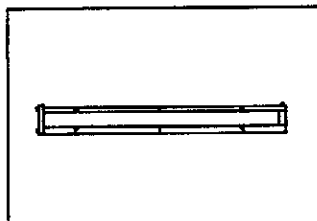

1Pc

T-03

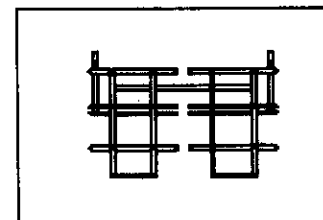

10Pcs

T-06

17997 Component list

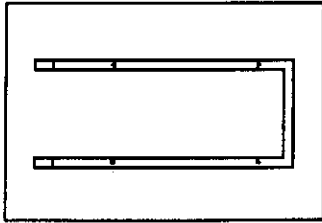

2Pc

T-07

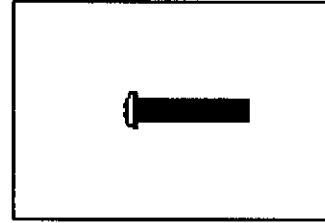

7Pcs

T-10

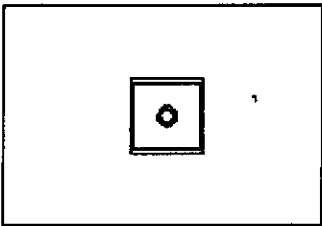

1Pc

T-08

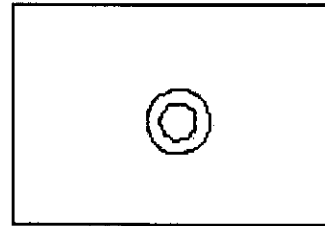

1Pc

T-11

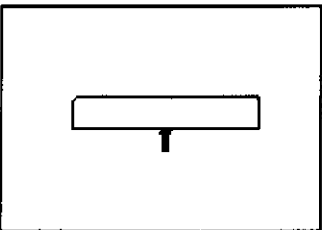

1Pc

T-09

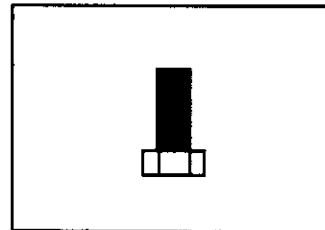

1Pc

T-12

INSTRUCTIONS

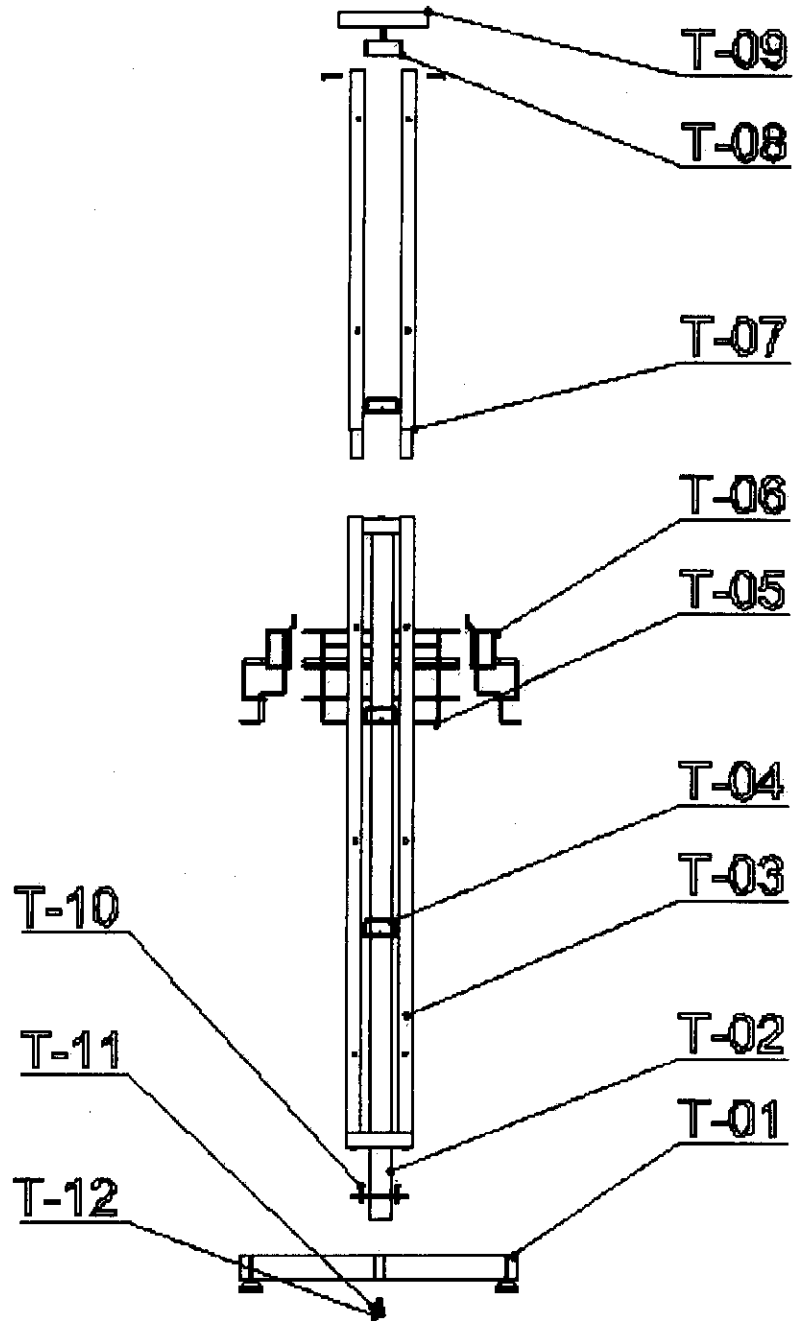

17997